

FIG. 3

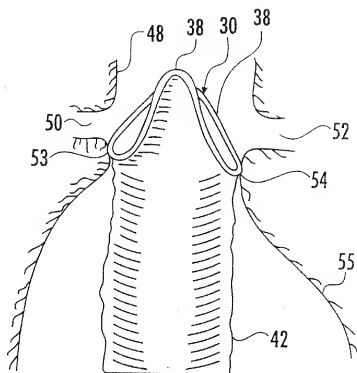

FIG. 4

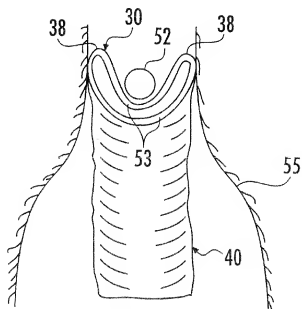
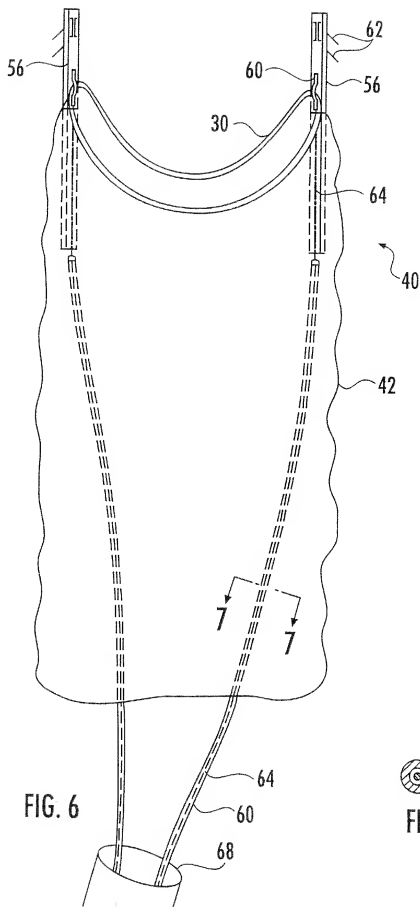
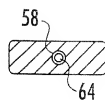
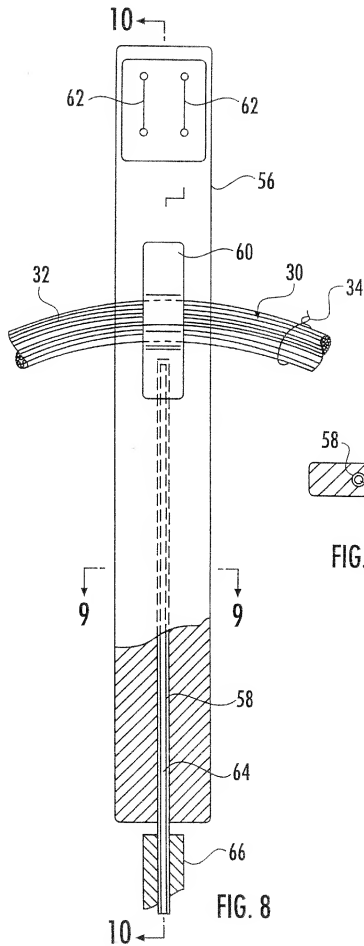
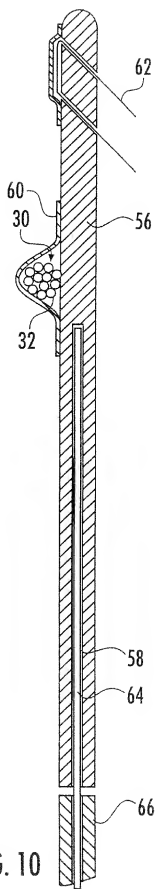

FIG. 5





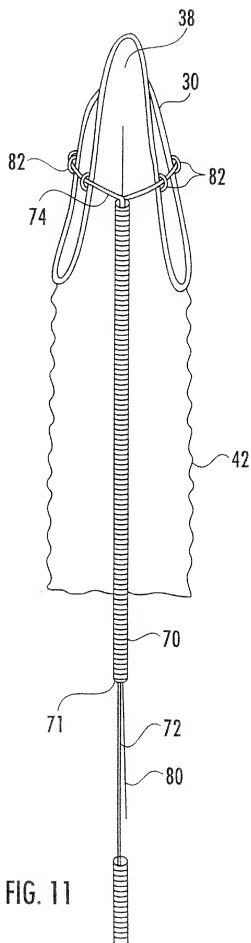

FIG. 11

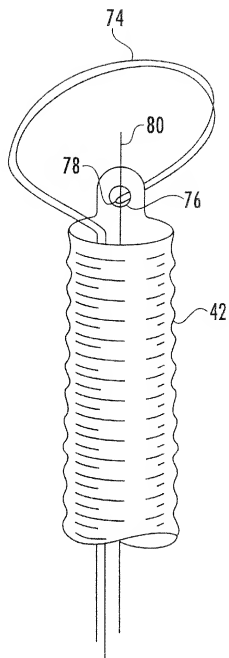

FIG. 12

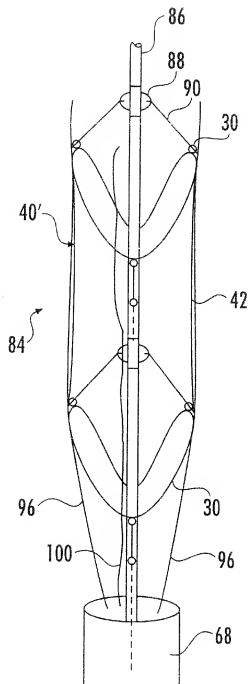

FIG. 13

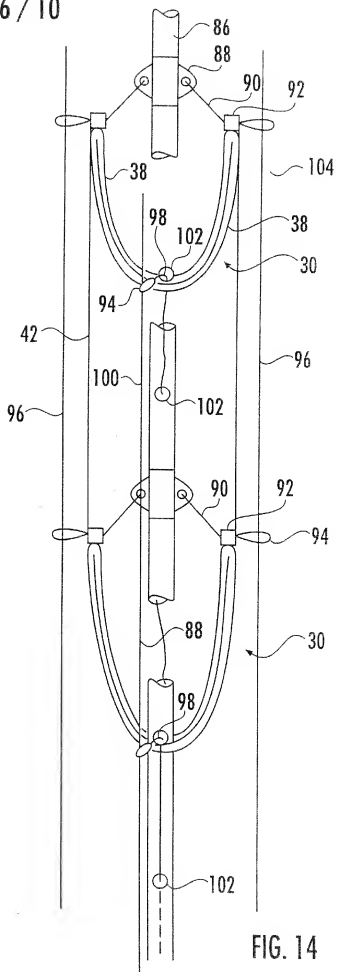

FIG. 14

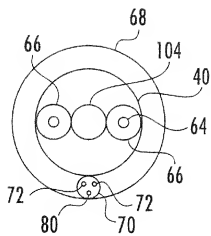

FIG. 15

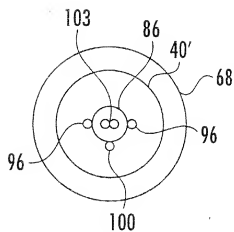

FIG. 16

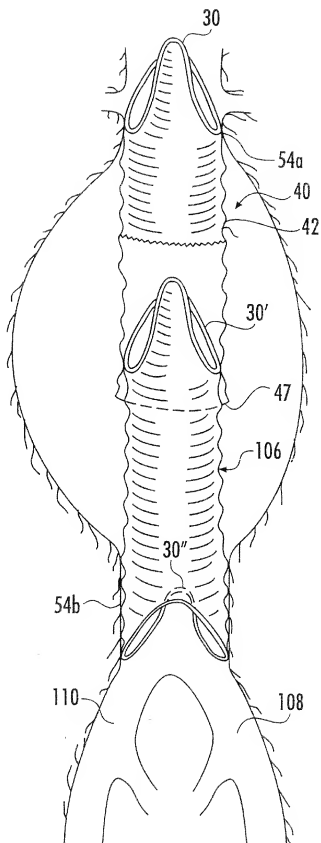
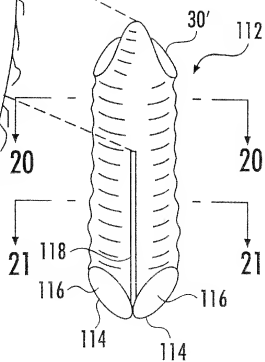
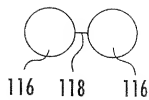
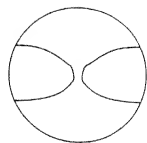
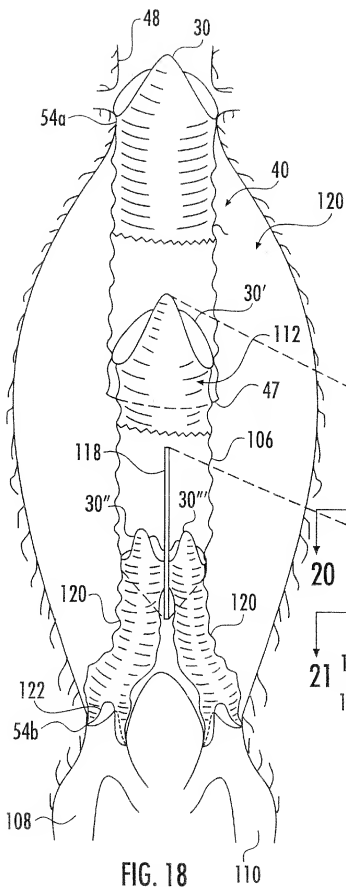
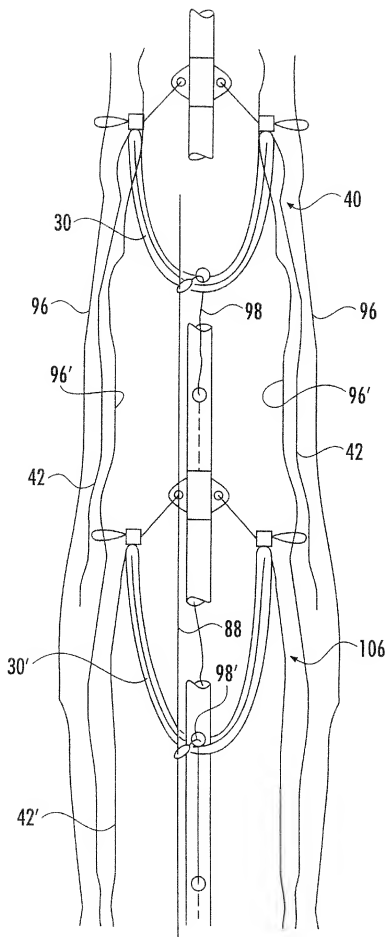

FIG. 17







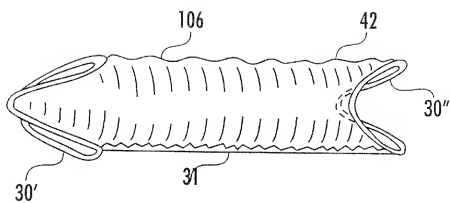

FIG. 23

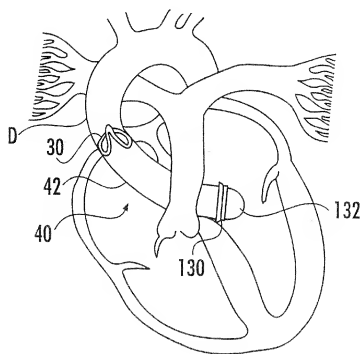

FIG. 24